

**TABELLA COLORI**  
 COLOR VARIATIONS  
 VARIANS COULEURS  
 FARBE VEÄNDERUNGEN

**STRUTTURE / STRUCTURES / STRUCTURE / STRUKTUR**



**SCHIENALI DI SERIE / STANDARD WALL CLADDINGS / REVETEMENTS MUR / MAUERVERKLEIDUNGEN**



**TOP RETRO REAR TOP / TOP ARRIERE / TOP RUECKSEITE**

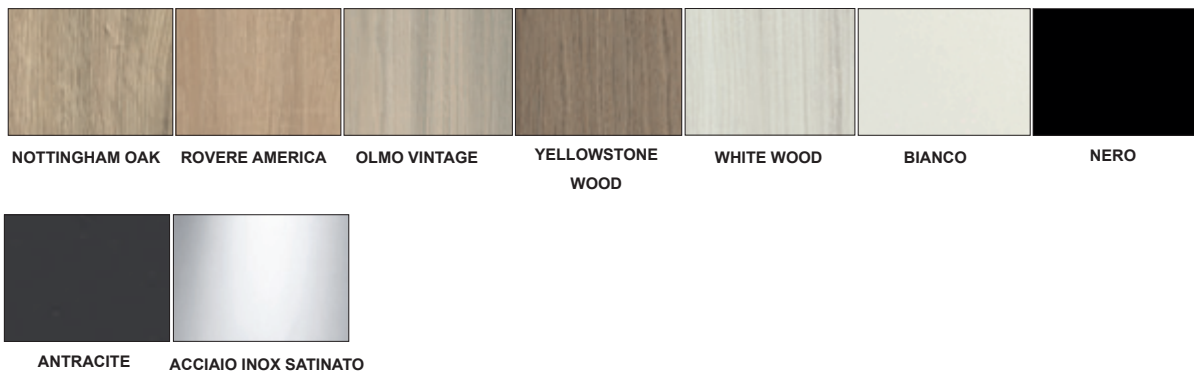

**MARMO / MARBLE / MARMOR / MARBRE**



# SCAFFALE - PROPOSTE COMPOSIZIONI

SHELF - Proposed Compositions -  
 Etagère - compositions de propositions  
 Regal - Vorschläge Zusammensetzungen

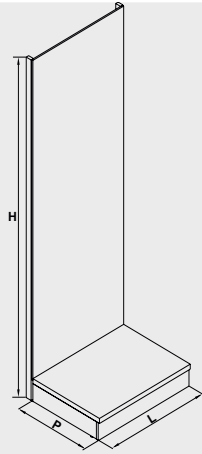

SCAFFALE CON RIPIANO BASE  
 BASIC SHELVES RACK MEUBLE DE BASE  
 BASISREGAL

L	P	H
750	400	2400
1000	400	2400
<hr/>		
750	550	2400
1000	550	2400
<hr/>		
750	650	2400
1000	650	2400

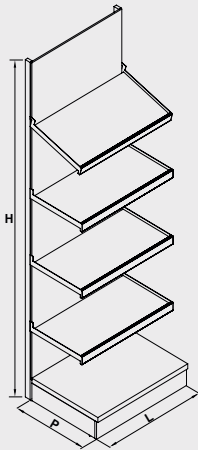

SCAFFALE CON RIPIANO BASE E MENSOLE  
 SHELVES RACK - MEUBLE AVEC ETAGERE - REGAL MIT  
 ABLAGE

L	P	H
750	400	2400
1000	400	2400
<hr/>		
750	550	2400
1000	550	2400
<hr/>		
750	650	2400
1000	650	2400

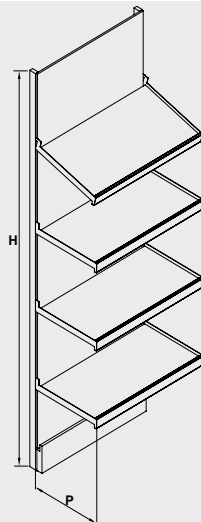

SCAFFALE CON MENSOLE  
 WALL SHELF - MEUBLE A MUR - WANDREGAL

L	P	H
750	350	2400
1000	350	2400
<hr/>		
750	400	2400
1000	400	2400

# SCAFFALE - PROPOSTE COMPOSIZIONI

SHELF - Proposed Compositions -  
 Etagère - compositions de propositions  
 Regal - Vorschläge Zusammensetzungen

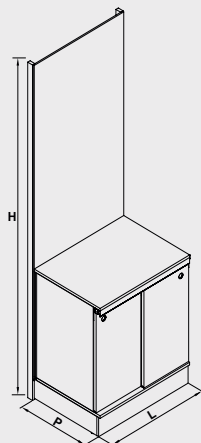

**SCAFFALE CON BASE H770**  
 SHELF WITH BASE H770 - MEUBLE AVEC BASE H770  
 REGAL MIT BASELEMENT H770

L	P	H
750	400	2400
1000	400	2400
<hr/>		
750	550	2400
1000	550	2400
<hr/>		
750	650	2400
1000	650	2400

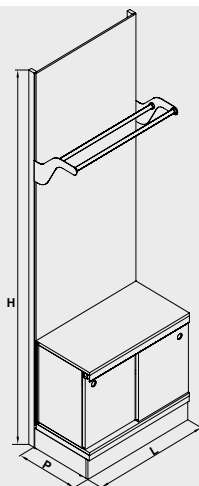

**SCAFFALE CON BASE H522 E GANCERA**  
 SHELF WITH BASE H522 AND INOX HOOKER SUPPORT  
 - MEUBLE AVEC BASE H522 ET INOXYDABLE SUPPORT  
 POUR CHROCHET - REGAL MIT BASELEMENT H522  
 UND HAKEN EDELSTAHL

L	P	H
750	400	2400
1000	400	2400
<hr/>		
750	550	2400
1000	550	2400
<hr/>		
750	650	2400
1000	650	2400

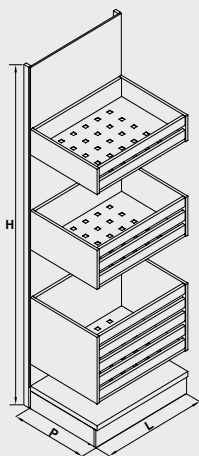

**SCAFFALE CON CESTI PICCOLO/MEDIO/  
 GRANDE CON PROFILI IN LEGNO**  
 SHELF WITH SMALL/MEDIUM/LARGE BREADBOX WITH  
 WOODEN PROFILES - MEUBLE AVEC PETIT/ MOYEN/  
 GRAND PAIN AVEC PROFILS EN BOIS - REGAL MIT UND  
 KLEINER/ MITTELGROßER/GROßER BROTKORB MIT  
 PROFILEN AUS HOLZ

L	P	H
750	400	2400
1000	400	2400
<hr/>		
750	550	2400
1000	550	2400
<hr/>		
750	650	2400
1000	650	2400

# SCAFFALE - PROPOSTE COMPOSIZIONI

SHELF - Proposed Compositions -  
Etagère - compositions de propositions  
Regal - Vorschläge Zusammensetzungen

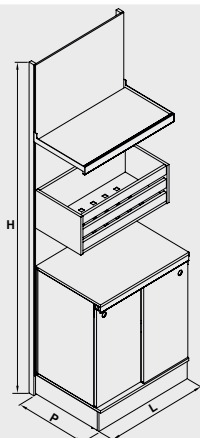

**SCAFFALE CON BASE H770/CESTO MEDIO CON PROFILI IN LEGNO/MENSOLA**  
SHELF WITH BASE H770 MEDIUM BREADBOX WITH WOODEN PROFILES/SHELF - MEUBLE AVEC BASE H770 MOYEN PAIN AVEC PROFILS EN BOIS/TABLETTE - REGAL MIT BASISELEMENT UND/ MITTELGROßER BROTKORB MIT PROFILEN AUS HOLZ/BRETT

L	P	H
750	400	2400
1000	400	2400
<hr/>		
750	550	2400
1000	550	2400
<hr/>		
750	650	2400
1000	650	2400

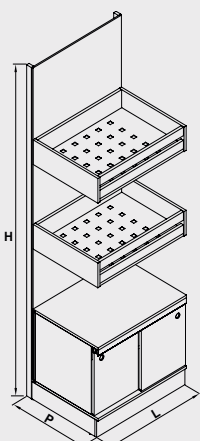

**SCAFFALE CON BASE H520/CESTI PICCOLI CON PROFILI IN LEGNO**  
SHELF WITH BASE H520 SMALL BREADBOX WITH WOODEN PROFILES - MEUBLE AVEC BASE H520 PETIT PAIN AVEC PROFILS EN BOIS - REGAL MIT BASISELEMENT H520 UND/ KLEINER BROTKORB MIT PROFILEN AUS HOLZ

L	P	H
750	400	2400
1000	400	2400
<hr/>		
750	550	2400
1000	550	2400
<hr/>		
750	650	2400
1000	650	2400

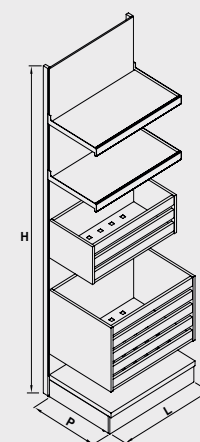

**SCAFFALE CON CESTI MEDIO/GRANDE CON PROFILI IN LEGNO E MENSOLE**  
SHELF WITH MEDIUM/ LARGE BREADBOX WITH WOODEN PROFILES AND SHELVES - MEUBLE AVEC MOYEN/ GRAND PAIN AVEC PROFILS EN BOIS ET TABLETTE - REGAL MIT UND/ MITTELGROßER/GROßER BROTKORB MIT PROFILEN AUS HOLZ UND BRETT

L	P	H
750	400	2400
1000	400	2400
<hr/>		
750	550	2400
1000	550	2400
<hr/>		
750	650	2400
1000	650	2400

# SCAFFALE - PROPOSTE COMPOSIZIONI

SHELF - Proposed Compositions -  
Etagère - compositions de propositions  
Regal - Vorschläge Zusammensetzungen

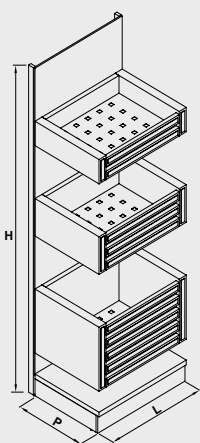

## SCAFFALE CON CESTI PICCOLO/MEDIO/ GRANDE IN LAMIERA

SHELF WITH METAL SMALL/MEDIUM/LARGE BREADBOX - MEUBLE AVEC PETIT/MOYEN/GRAND PAIN EN TOLE - REGAL MIT UND KLEINER/ MITTELGROßER/ GROßER BROTKORB AUS BLECH

L	P	H
750	400	2400
1000	400	2400
<hr/>		
750	550	2400
1000	550	2400
<hr/>		

750	650	2400
1000	650	2400

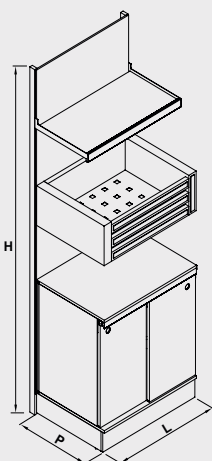

## SCAFFALE CON BASE H770 - CESTO MEDIO IN LAMIERA - MENSOLA

SHELF WITH BASE H770 MEDIUM METAL BREADBOX AND SHELF - MEUBLE AVEC BASE H770 MOYEN PAIN EN TOLE ET TABLETTE - REGAL MIT BASELEMENT UND/ MITTELGROßER BROTKORB AUS BLECH/ BRETT

L	P	H
750	400	2400
1000	400	2400
<hr/>		
750	550	2400
1000	550	2400
<hr/>		

750	650	2400
1000	650	2400

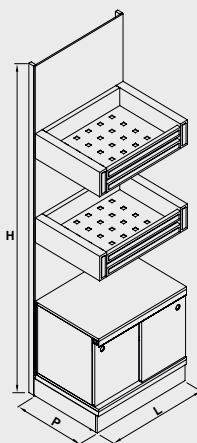

## SCAFFALE CON BASE H520/CESTI PICCOLI IN LAMIERA

SHELF WITH BASE H520 METAL SMALL BREADBOX - MEUBLE AVEC BASE H520 PETIT PAIN EN TOLE - REGAL MIT BASELEMENT H520 UND/ KLEINER BROTKORB AUS BLECH

L	P	H
750	400	2400
1000	400	2400
<hr/>		
750	550	2400
1000	550	2400
<hr/>		

750	650	2400
1000	650	2400

# SCAFFALE - PROPOSTE COMPOSIZIONI

SHELF - Proposed Compositions -  
 Étagère - compositions de propositions  
 Regal - Vorschläge Zusammensetzungen

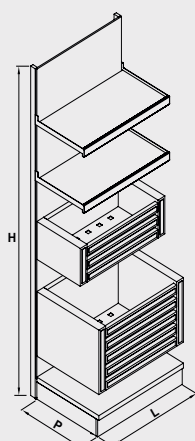

## SCAFFALE CON CESTI MEDIO/GRANDE IN LAMIERA E MENSOLE

SHELF WITH METAL MEDIUM/LARGE BREADBOX  
 - MEUBLE AVEC MOYEN/GRAND PAIN EN TOLE ET  
 TABLETTE - REGAL MIT UND MITTELGROßER/GROßER  
 BROTKORB AUS BLECH UND BRETT

L	P	H
750	400	2400
1000	400	2400
<hr/>		
750	550	2400
1000	550	2400

750	650	2400
1000	650	2400

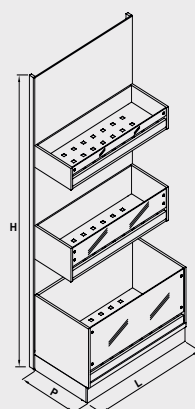

## SCAFFALE CON CESTI PICCOLO/MEDIO/GRANDE IN VETRO

SHELF WITH SMALL/MEDIUM/LARGE GLASS  
 BREADBOX - MEUBLE AVEC PETIT/MOYEN/GRAND  
 PAIN EN VERRE - REGAL MIT UND KLEINER/ MITTEL-  
 GROßER/GROßER BROTKORB AUS GLAS

L	P	H
750	400	2400
1000	400	2400
<hr/>		
750	550	2400
1000	550	2400

750	650	2400
1000	650	2400

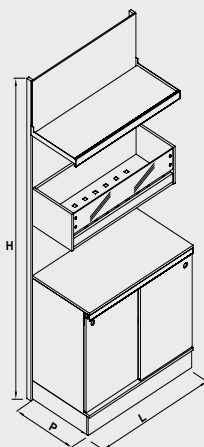

## SCAFFALE CON BASE H770 - CESTO MEDIO IN VETRO - MENSOLA

SHELF WITH BASE H770 MEDIUM GLASS BREADBOX  
 AND SHELF - MEUBLE AVEC BASE H770 MOYEN PAIN  
 EN VERRE ET TABLETTE - REGAL MIT BASISLEMENT  
 UND/ MITTELGROßER BROTKORB AUS GLAS/ BRETT

L	P	H
750	400	2400
1000	400	2400
<hr/>		
750	550	2400
1000	550	2400

750	650	2400
1000	650	2400

# SCAFFALE - PROPOSTE COMPOSIZIONI

SHELF - Proposed Compositions -  
 Étagère - compositions de propositions  
 Regal - Vorschläge Zusammensetzungen

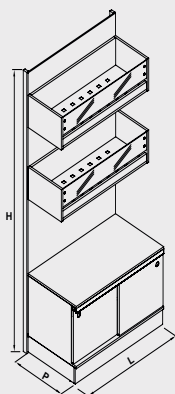

## SCAFFALE CON BASE H520/CESTI PICCOLI IN VETRO

SHELF WITH BASE H520 GLASS SMALL BREADBOX -  
 MEUBLE AVEC BASE H520 PETIT PAIN EN  
 VERRE - REGAL MIT BASISSELEMENT H520 UND/  
 KLEINER BROT KORB AUS GLAS

L	P	H
750	400	2400
1000	400	2400
<hr/>		
750	550	2400
1000	550	2400
<hr/>		
750	650	2400
1000	650	2400

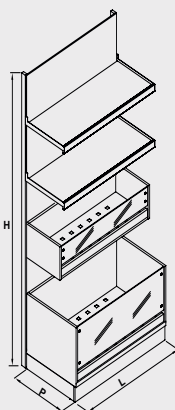

## SCAFFALE CON CESTI MEDIO/GRANDE IN VETRO E MENSOLE

SHELF WITH GLASS MEDIUM/LARGE BREADBOX -  
 MEUBLE AVEC MOYEN/GRAND PAIN EN VERRE ET  
 TABLETTE - REGAL MIT UND MITTELGROßER/GROßER  
 BROT KORB AUS GLAS UND BRETT

L	P	H
750	400	2400
1000	400	2400
<hr/>		
750	550	2400
1000	550	2400
<hr/>		
750	650	2400
1000	650	2400

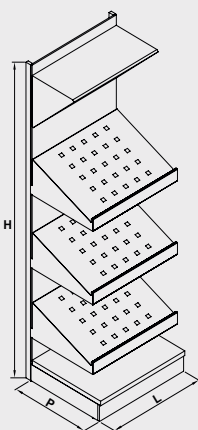

## SCAFFALE CON MENSOLE ORTOFRUTTA

SHELF WITH FRUIT AND VEGETABLE SHELF -  
 MEUBLE AVEC FRUITS ET LEGUMES TABLETTE -  
 REGAL MIT UND OBST-UND GEMUSEREAL

L	P	H
750	400	2400
1000	400	2400
<hr/>		
750	550	2400
1000	550	2400
<hr/>		
750	650	2400
1000	650	2400

# SCAFFALE - PROPOSTE COMPOSIZIONI

SHELF - Proposed Compositions -  
Etagère - compositions de propositions  
Regal - Vorschläge Zusammensetzungen

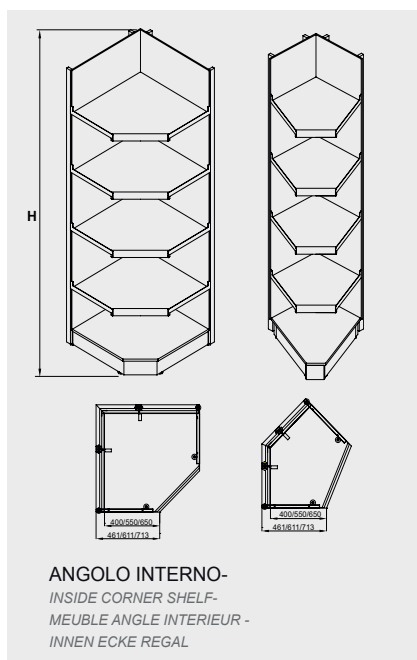

L	P	H
45°	400	2400
90°	400	2400
<hr/>		
45°	550	2400
90°	550	2400
<hr/>		
45°	650	2400
90°	650	2400

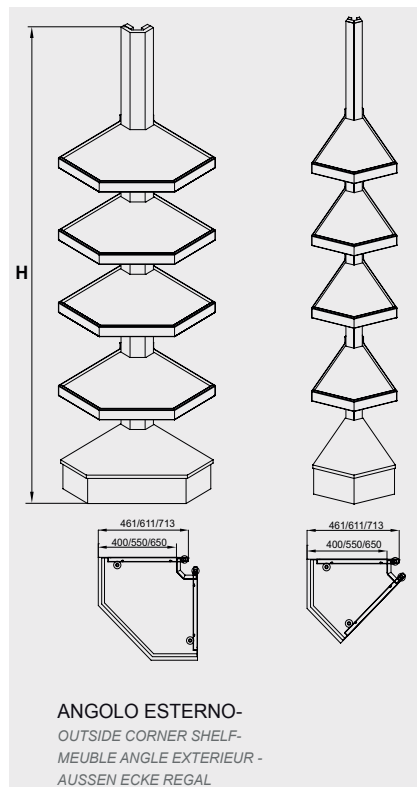

L	P	H
45°	400	2400
90°	400	2400
<hr/>		
45°	550	2400
90°	550	2400
<hr/>		
45°	650	2400
90°	650	2400

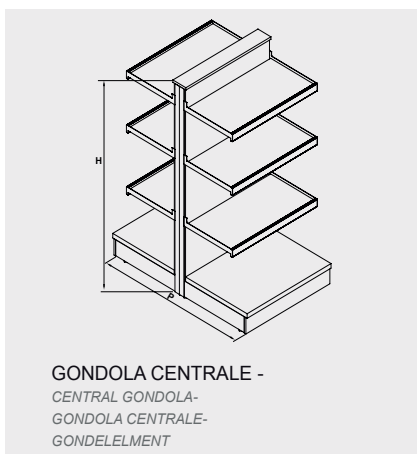

L	P	H
750	980	1600
750	1280	1600
<hr/>		
1000	980	1600
1000	1280	1600



# SCAFFALE - PROPOSTE COMPOSIZIONI

SHELF - Proposed Compositions -  
 Étagère - compositions de propositions  
 Regal - Vorschläge Zusammensetzungen

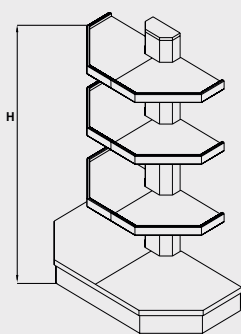

GONDOLA TERMINALE -  
 GONDOLA END-  
 FINAL GONDOLE-  
 END GONDEL

L	P	H
	1015	1660
	1315	1660
<b>MONTANTE</b>		
STRUCTURAL		H
MONTANT - STÄNDER		
		1660
		1600

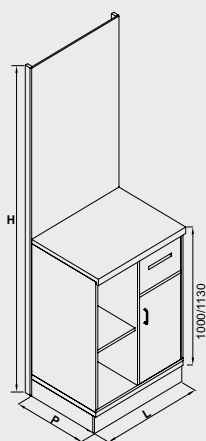

SCAFFALE MACCHINA CAFFE' CON  
 STRUTTURA IN TUBOLARE DI ALLUMI-  
 NIO-

SHELF COFFE MACHINE WITH STRUCTURE OF TU-  
 BULAR ALUMINIUM- MEUBLE/MACHINE A CAFE' AVEC  
 STRUCTURE EN ALUMINIUM TUBULAIRE- REGAL  
 KAFFEE MASCHINE UND STRUKTUR AUS  
 ALUMINIUMROHR

L	P	H
1000	550	2400
1500	550	2400
<hr/>		
1000	650	2400
1500	650	2400

# COMPONENTI SCAFFALI

Shelves component  
Meuble composants  
Regal Komponenten

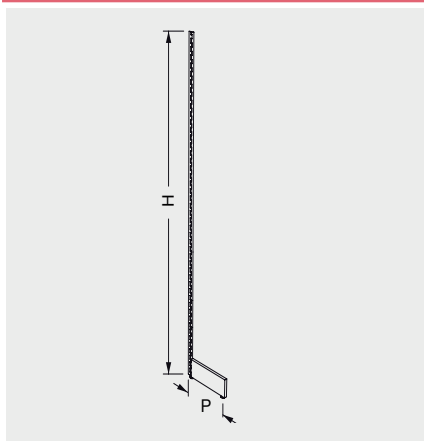

	P	H
	411	2400
	561	2400
	663	2400

## SET MONTANTE IN METALLO CON BASE

STRUCTURAL FINISHING SIDE IN METAL WITH BASE  
SET MONTANT EN MÉTAL AVEC BASE  
STÄNDER-SET AUS METALL MIT SOCKEL

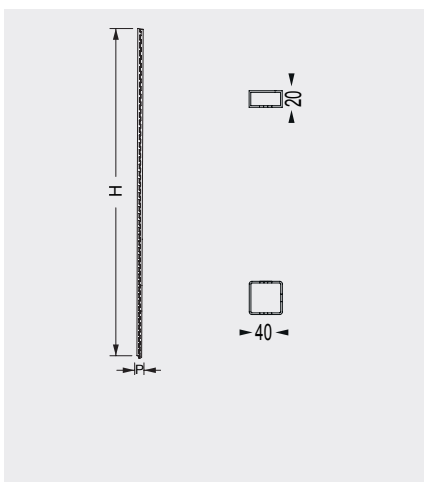

L	P	H
40	20	2400

## MONTANTE LATERALE DX/SX

STRUCTURAL FINISHING SIDE DX/SX  
MONTANT DE FINITION DX/SX - STÄNDER DX/SX

L	P	H
40	40	2400

## MONTANTE CENTRALE

STRUCTURAL FINISHING SIDE  
MONTANT DE FINITION - STÄNDER

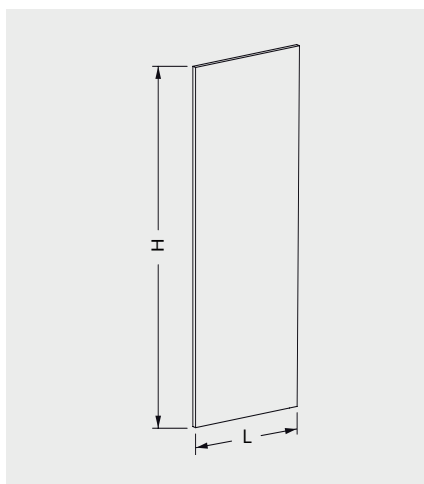

L	H
750	2400
1000	2400

## ELEMENTO SCHIENALE

BACK ELEMENT - ÉLÉMENT DOSSIER - RÜCKENWANDELEMENT

## MAGGIORAZIONE SCHIENALE CON LAMINATO A SCELTA

EXTRA CHARGE FOR BACK ELEMENT WITH LAMINATE CHOICE  
MAJORATION PUOR ÉLÉMENT DOSSIER AVEC STRATIFIÉ UN CHOIX  
AUFPREIS FUER RÜCKENWANDELEMENT MIT LAMINATE WAHL

L 750

L 1000

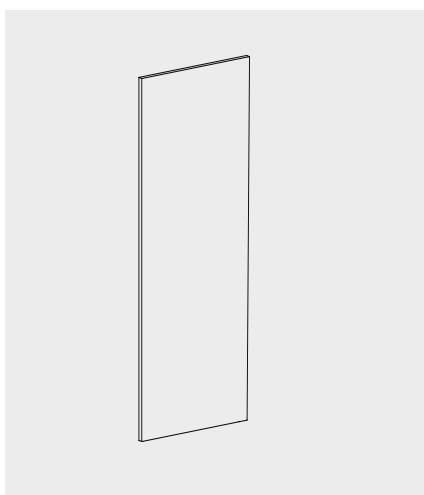

## PANNELLO DI RIVESTIMENTO IN NOBILITATO AL MQ

FINISHING PANEL WOOD FOR S.M.  
PANNEAU DE REVÊTEMENT EN BOIS AU MQ  
VERKLEIDUNGSPANEEL HOLZ JE MQ

## (BORDO COMPRESO)

(BORDER INCLUDED)  
(BORD COMPRIS)  
(INKLUSIVE RAND)

# COMPONENTI SCAFFALI

*Shelves component  
Meuble composants  
Regal Komponenten*

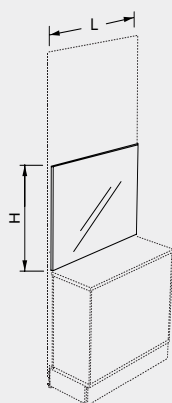

L	H
750	720
1000	720
750	520
1000	520

## ACCIAIO INOX PER SCHIENALE

*STAINLESS STEEL FOR WALL CLADDING  
ACIER INOX POUR REVETMENT MUR  
ROSTFREIER STAHL FUER MAUERVERKLEIDUNG*

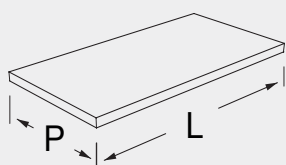

L	P
750	400
1000	400
750	550
1000	550
750	650
1000	650

## PIANO BASE IN LEGNO

*WOODEN BASE TOP - DESSUS BASE EN BOIS - BASIS-HOLZFLAECHE*

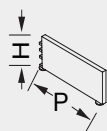

P	H
400	133
550	133
650	133

## BASE MONTANTE

*STAND BASE - MONTANT DE BASE - STÄNDERBASISELEMENT*

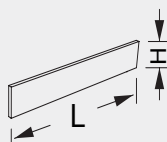

L
750
1000

## ZOCCOLO BASE

*BASE SOCLE - SOUBASSEMENT DE BASE - BASISOCKEL*

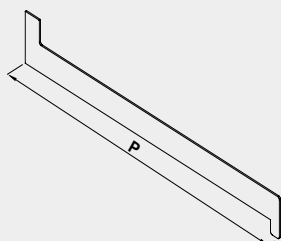

P
350 DX
350 SX
400 DX
400 SX

## REGGI-MENSOLA PER MENSOLA IN LEGNO

*SHELF HOLDER FOR WOOD SHELF  
PORTE-TABLETTE POUR TABLETTES EN BOIS  
BRETT-HALTER FUER BRETTE AUS HOLZ*

# COMPONENTI SCAFFALI

Shelves component  
Meuble composants  
Regal Komponenten

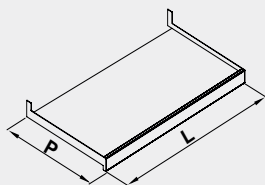

L	P
750	350
1000	350
750	400
1000	400

## MENSOLA IN LEGNO CON REGGI-MENSOLA E FRONTALINO PERSONALIZZABILE

WOODEN SHELF WITH SHELF HOLDER AND PERSONALIZABLE FRONT

TABLETTE EN BOIS AVEC PORTE-TABLETTE ET FAÇADE PERSONNALISABLE

BRETT AUS HOLZ MIT BRETT-HALTER UND FRONTPLATTE WO MANN DIER PERSOENLICHE NOTE GEBEN KANN

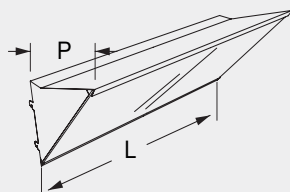

L	P
750	389
1000	389

## SPECCHIO INCLINATO SCAFFALE

INCLINED MIRROR SHELF - MIROIR INCLINÉ ÉTAGÈRE - SCHIEFER SPIEGEL REGAL

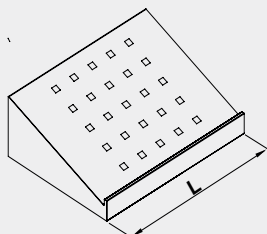

L	P
750	550
1000	550

## MENSOLA ORTOFRUTTA

FRUIT AND VEGETABLE SHELF

FRUITS ET LEGUMES TABLETTE

OBST-UND GEMUSEREGAL

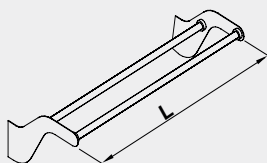

L	P
750	323
1000	323

## GANCERA INOX

INOX HOOKER SUPPORT

INOXYDABLE SUPPORT POUR CHROCHET

HAKEN EDELSTAHL

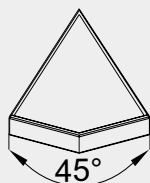
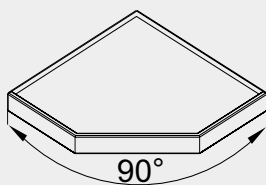

L	P
AE 45°	350
AE 45°	400
AE 90°	350
AE 90°	400

## MENSOLA IN LEGNO CON REGGI-MENSOLA E FRONTALINO PERSONALIZZABILE

WOODEN SHELF WITH SHELF HOLDER AND PERSONALIZABLE FRONT

TABLETTE EN BOIS AVEC PORTE-TABLETTE ET FAÇADE PERSONNALISABLE

BRETT AUS HOLZ MIT BRETT-HALTER UND FRONTPLATTE WO MANN DIER PERSOENLICHE

# COMPONENTI SCAFFALI

Shelves component  
Meuble composants  
Regal Komponenten

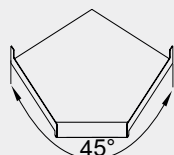
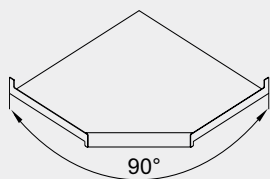

L	P
Al 45°	350
Al 45°	400
Al 90°	350
Al 90°	400

## MENSOLA IN LEGNO CON REGGI-MENSOLA E FRONTALINO PERSONALIZZABILE

WOODEN SHELF WITH SHELF HOLDER AND PERSONALIZABLE FRONT

TABLETTE EN BOIS AVEC PORTE-TABLETTE ET FAÇADE PERSONNALISABLE

BRETT AUS HOLZ MIT BRETT-HALTER UND FRONTPLATTE WO MANN DIER PERSOENLICHE

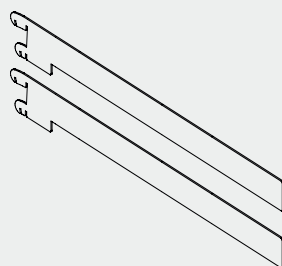

L	P	
406	350 DX	(PI) (ME)
406	350 SX	(PI) (ME)
456	400 DX	(MA)
456	400 SX	(MA)

## REGGI-MENSOLA PER CESTI PANE -

SHELF HOLDER FOR BREAD BASKETS

SUPPORT ETAGERE POUR PANIERS PAIN - ABLAGEHALTER FÜR BROTKÖRBE

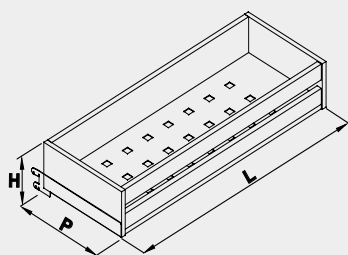

L	P	H
750	380	175
1000	380	175

## PORTAPANE PICCOLO con profili in legno - compreso di raccoglibriciole

SMALL BREADBOX WITH WOODEN PROFILES - crumb tray included

PRESENTOIR A' PAIN PETIT AVEC PROFILS EN BOIS - avec bac à miettes

KLEINER BROTKORB MIT PROFILEN AUS HOLZ - inklusive Krümelsammler

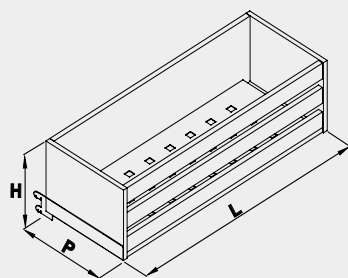

L	P	H
750	380	270
1000	380	270

## PORTAPANE MEDIO con profili in legno - compreso di raccoglibriciole

MEDIUM BREADBOX WITH WOODEN PROFILES - crumb tray included

PRESENTOIR A' PAIN MOYEN AVEC PROFILS EN BOIS - avec bac à miettes

MITTELGROßER BROTKORB MIT PROFILEN AUS HOLZ - inklusive Krümelsammler

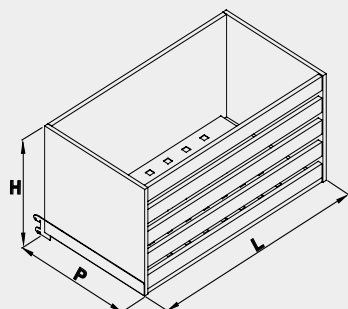

L	P	H
750	550	480
1000	550	480

## PORTAPANE GRANDE con profili in legno - compreso di raccoglibriciole

LARGE BREADBOX WITH WOODEN PROFILES - crumb tray included

PRESENTOIR A' PAIN GRAND AVEC PROFILS EN BOIS - avec bac à miettes

GROßER BROTKORB MIT PROFILEN AUS HOLZ - inklusive Krümelsammler

# COMPONENTI SCAFFALI

Shelves component  
Meuble composants  
Regal Komponenten

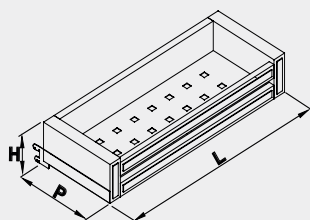

L	P	H
750	380	175
1000	380	175

## PORTAPANE PICCOLO in lamiera e inserti in legno - compreso di raccoglibriciole

SMALL METAL SHEET BREADBOX WITH WOODEN INSERT - crumb tray included  
PRESENTOIR A' PAIN PETIT EN TÔLE ET INSERTS EN BOIS - avec bac à miettes  
KLEINER BROTKORB AUS BLECH MIT HOLZEINLAGEN - inklusive Krümelsammler

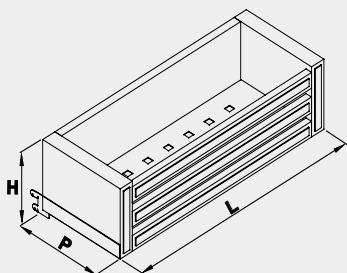

L	P	H
750	380	260
1000	380	260

## PORTAPANE MEDIO in lamiera e inserti in legno - compreso di raccoglibriciole

MEDIUM METAL SHEET BREADBOX WITH WOODEN INSERT - crumb tray included  
PRESENTOIR A' PAIN MOYEN EN TÔLE ET INSERTS EN BOIS - avec bac à miettes  
MITTELGROßER BROTKORB AUS BLECH MIT HOLZEINLAGEN - inklusive Krümelsammler

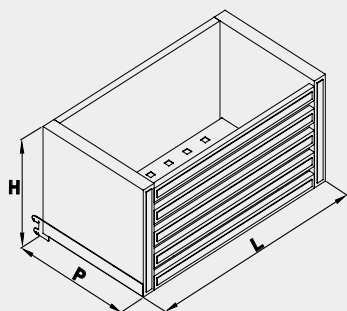

L	P	H
750	550	425
1000	550	425

## PORTAPANE GRANDE in lamiera e inserti in legno - compreso di raccoglibriciole

LARGE METAL SHEET BREADBOX WITH WOODEN INSERT - crumb tray included  
PRESENTOIR A' PAIN GRAND EN TÔLE ET INSERTS EN BOIS - avec bac à miettes  
GRÖßER BROTKORB AUS BLECH MIT HOLZEINLAGEN - inklusive Krümelsammler

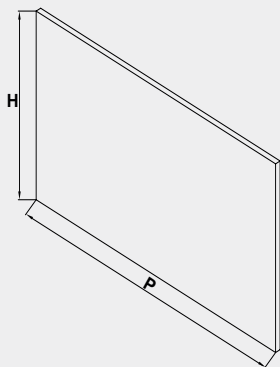

**PICCOLO** - SMALL-PETIT-KLEIN

**MEDIO** - MIDLE -MITTEL-MOYEN

**GRANDE** - LARGE -GROS -GRAND

## DIVISORI VETRO PER CESTO PORTAPANE in legno o lamiera

GLASS PARTITION FOR METAL SHEET OR WOODEN BREADBOX  
SEPARATION EN VERRE POUR PRESENTOIR A' PAIN EN BOIS OU EN TÔLE  
TRENNELEMENT AUS GLAS FÜR KORB AUS HOLZ ODER BLECH

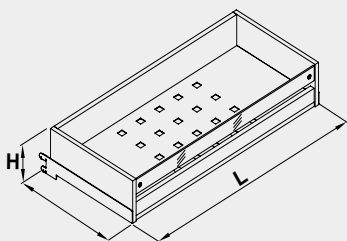

L	P	H
750	380	175
1000	380	175

## PORTAPANE PICCOLO IN VETRO - compreso di raccoglibriciole

SMALL GLASS BREADBOX - crumb tray included  
PRESENTOIR A' PAIN PETIT EN VERRE - avec bac à  
KLEINER BROTKORB AUS GLAS - inklusive Krümelsammler

# COMPONENTI SCAFFALI

Shelves component  
Meuble composants  
Regal Komponenten

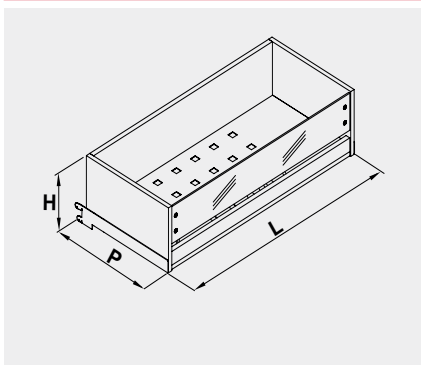

L	P	H
750	380	270
1000	380	270

## PORTAPANE MEDIO IN VETRO- compreso di raccoglibriciole

MEDIUM GLASS BREADBOX - crumb tray included  
PRESENTOIR A' PAIN MOYEN AVEC PROFILS EN VERRE- avec bac à miettes  
MITTELGROßER BROTKORB MIT PROFILEN AUS GLAS- inklusive Krümelsammler

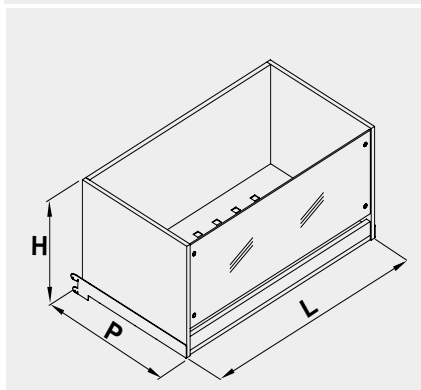

L	P	H
750	550	480
1000	550	480

## PORTAPANE GRANDE IN VETRO - compreso di raccoglibriciole

LARGE GLASS BREADBOX - crumb tray included  
PRESENTOIR A' PAIN GRAND EN VERRE - avec bac à miettes  
GROßER BROTKORB AUS GLAS - inklusive Krümelsammler

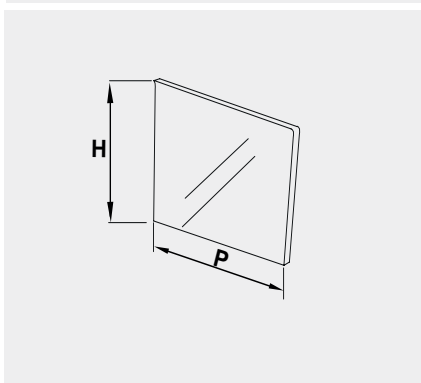

L	P	H

**PICCOLO** - SMALL-PETIT-KLEIN

**MEDIO** - MIDDLE-MITTEL-MOYEN

**GRANDE** - LARGE -GROS -GRAND

## DIVISORI VETRO PER CESTO PORTAPANE in vetro

GLASS PARTITION FOR GLASS BREADBOX  
SEPARATION EN VERRE POUR PRESENTOIR A' PAIN EN VERRE  
TRENNELEMENT AUS GLAS FÜR BROTKORB AUS GLAS

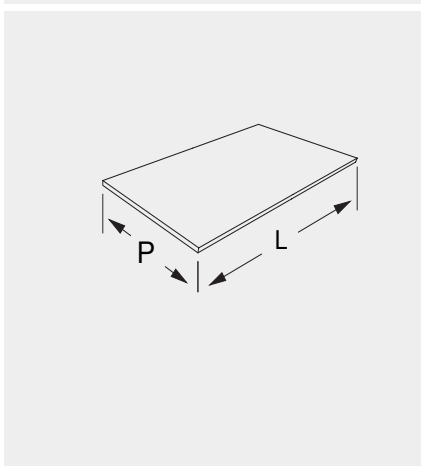

L	P	H

750

**PICCOLO** - SMALL-PETIT-KLEIN

1000

750

**MEDIO** - MIDDLE-MITTEL-MOYEN

1000

750

**GRANDE** - LARGE-GROS-GRAND

1000

## COPERCHIO IN PLEXIGLAS PER CESTI PORTAPANE

PLEXIGLAS COVER FOR BREAD BASKETS COUVERCLE POUR PANIER EN PLEXIGLAS- ABDECKUNG FÜR BROTKORB AUS PLEXIGLAS

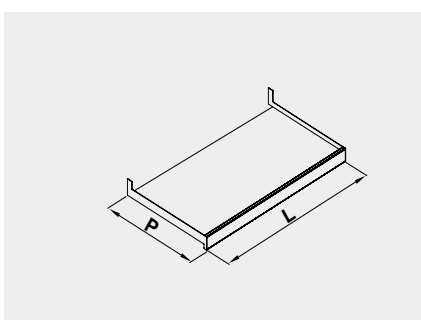

L	P	H

750

350

1000

350

## CIELINO IN LEGNO SENZA ILLUMINAZIONE

WOODEN CEILING WITHOUT LIGHTING  
PLAFOND EN BOIS SANS ÉCLAIRAGE  
DECKPLATTE AUS HOLZ OHNE BELEUCHTUNG

# COMPONENTI SCAFFALI

*Shelves component  
Meuble composants  
Regal Komponenten*

## ILLUMINAZIONE CON LUCE LED/ML PER OGNI MENSOLA E CIELINO

*INCREASE FOR LED LIGHT/ML FOR EVERY SHELVES AND CEILING  
AUGMENTACION POUR LED ML POUR ETAGERES ET PLAFOND  
PREISAUFSCHLAG LED-BELEUCHTUNG FUR EINLEGEBODEN UND DECKPLATTE*

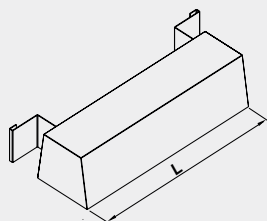

L		
---	--	--

750

1000

## PLAFONIERA METALLICA CON ILLUMINAZIONE A LED

*METAL CEILING PANEL WITH LED LIGHTING STAHL  
LAMP DE PLAFOND METALLIQUE AVEC ECLAIRAGE LED  
METALLISCHE DECKENLEUCHTE MIT LED-BELEUCHTUNG*

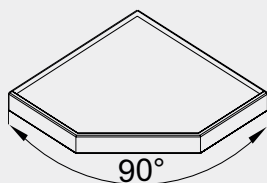

L	P	
---	---	--

AE 45°

615

AE 90°

615

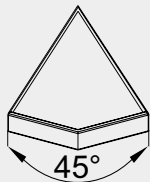

## CIELINO IN LEGNO PER ANGOLO ESTERNO

*WOODEN CEILING FOR OUTSIDE CORNER  
PLAFOND EN BOIS POUR ANGLE EXTERIEUR  
DECKPLATTE FUER AUSSENECKE*

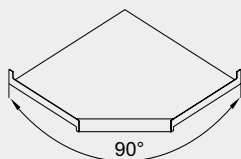

L	P	
---	---	--

AI 45°

615

AI 90°

615

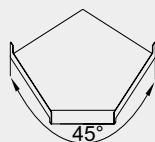

## CIELINO IN LEGNO PER ANGOLO INTERNO

*WOODEN CEILING FOR INSIDE CORNER  
PLAFOND EN BOIS POUR ANGLE INTERIEUR  
DECKPLATTE AUS HOLZ*

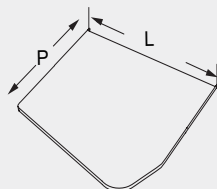

L	P	
---	---	--

750

600-750-850

1000

600-750-850

## PIANO AFFETTATRICE IN ACCIAIO INOX

*SLICING MACHINE TOP IN STAINLESS STEEL  
DESSUS COUPE - JAMBON EN ACIER INOX  
AUFSCHNITTMASCHINE FLAECHEN AUS ROSTFREIE*



## COMPONENTI SCAFFALI

Shelves component  
Meuble composants  
Regal Komponenten

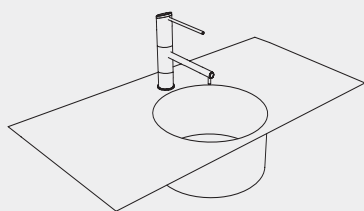

LAVELLO AD INCASSO Ø 30

LAVELLO AD INCASSO Ø 38

LAVELLO SALDATO Ø 42

LAVELLO AD INCASSO Ø 42

### LAVELLO CON MISCELATORE

SINK WITH MIXER - ÉVIER AVEC MELANGEUR - SPÜLE MIT MISCHBATTERIE

### IL LAVELLO SALDATO Ø 42 PUÒ ESSERE INSERITO SOLO SULLE BASI PROF. 65

IS POSSIBLE TO INSERT THE WELDED SINK ONLY ON THE BASE DEPTH. 65

L'ÉVIER SOUDÉ PEUT ÊTRE INSÉRÉ SEULEMENT SUR LES BASE PROF.65

DIE ANGESCHWEISSTE SPÜLE IST NUR AUF IHRE BASISSELEMENT TIEFE 65

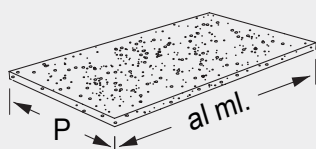

L

P

425

575

675

### TOP RETRO IN MARMO SINTETICO al ml

BACK TOP IN SYNTHETIC (each meter) - ARRIERE TOP EN SYNTHETIQUE (mètre linéar)

INNEN-TOP AUS SYNTHETISCHEN (am Meter)

425

575

675

### TOP RETRO IN MARMO al ml

BACK TOP IN MARBLE (each meter) - ARRIERE TOP EN MARBRE (mètre linéar) - TOP AUS MARMOR (am Meter)

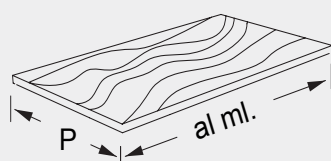

L

P

425

575

675

### TOP RETRO IN LEGNO al ml. -TOP BACK IN WOOD (each metre)

TOP DERRIÈRE EN BOIS (au mètre) - TOP RUECKSEITE AUS HOLZ (am Meter)

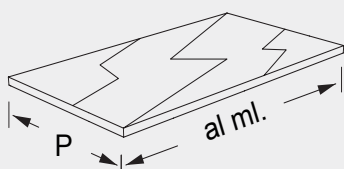

L

P

425

575

675

### TOP RETRO INOX al ml.

TOP BACK STAINLESS STEEL each metre

TOP derrière INOX au mètre

TOP RUECKSEITE ROSTFREIER STAHL am Meter

# COMPONENTI SCAFFALI

Shelves component  
Meuble composants  
Regal Komponenten

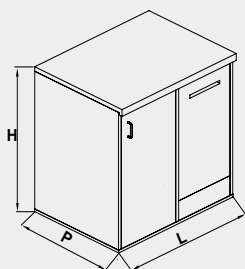

L	P	
1000	550	770
1000	650	770

## BASE NEUTRA CON ANTINA E TRAMOGGIA RIFIUTI - LEGNO

NEUTRAL BASE WITH SMALL DOOR AND WASTE HOPPER - WOOD  
BASE NEUTRE AVEC PETITE PORTE ET trémie DES ORDURES - BOIS  
NEUTRALER SOCKEL MIT TUERCHEN UND ABFALL TRICHTER - HOLZ

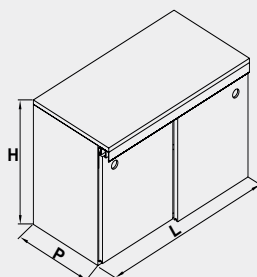

L	P	
750	400	522
750	550	522
750	650	522
1000	400	522
1000	550	522
1000	650	522

## BASE NEUTRA BASSA CON SCORREVOLI E RIPIANO INTERMEDIO - LEGNO

LOW NEUTRAL BASE WITH SLIDING DOORS AND INTERMEDIATE SHELF - WOOD  
BASE NEUTRE BASSE AVEC COULISSANT ET PLAN INTERMÉDIAIRE - BOIS  
NIEDRIG NICHTKÜHLBASELEMENT MIT SCHIEBETÜREN UND ZWISCHENABLAGE - HOLZ

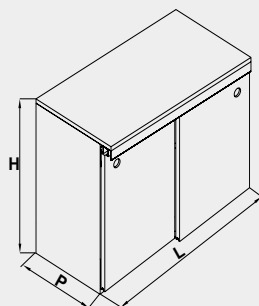

L	P	
750	400	770
750	550	770
750	650	770
1000	400	770
1000	550	770
1000	650	770

## BASE NEUTRA CON SCORREVOLI E RIPIANO INTERMEDIO - LEGNO

NEUTRAL BASE WITH SLIDING DOORS AND INTERMEDIATE SHELF - WOOD  
BASE NEUTRE AVEC COULISSANT ET PLAN INTERMÉDIAIRE - BOIS  
NICHTKÜHLBASELEMENT MIT SCHIEBETÜREN UND ZWISCHENABLAGE - HOLZ

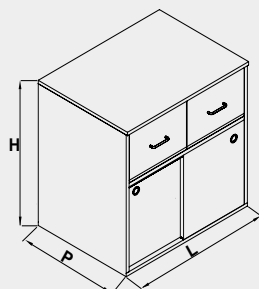

L	P	
750	400	770
750	550	770
750	650	770
1000	400	770
1000	550	770
1000	650	770

## BASE NEUTRA CON SCORREVOLI E CASSETTI - LEGNO

NEUTRAL BASE WITH SLIDING DOORS AND DRAWERS - WOOD  
BASE NEUTRE AVEC COULISSANT ET TIROIRS - BOIS  
NICHTKÜHLBASELEMENT MIT SCHIEBETÜREN UND SCHUBLADEN - HOLZ

# COMPONENTI SCAFFALI

Shelves component  
Meuble composants  
Regal Komponenten

L 1500

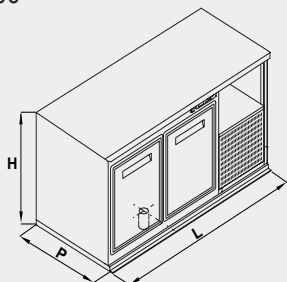

## BASE REFRIGERATA H 770

REFRIGERATED BASE H 770

BASE RÉFRIGÉRÉE H 770

GEKUEHLTES BASIS H 770

L	P	
L 1500 (2 FORI) STATICA	550	MI
	650	ME
		MI
		ME

MI - Motore interno-Internal motor-Moteur interne-Interner MotorInternal motor-Moteur interne-interner

ME - Motore esterno non fornito - External motor not supplied -Moteur externe non fourni - Externer Motor, nicht mitgeliefert

ENTRO 3MT - UP TO 3MT - JUSQU A 3M- BIS 3M

14UC359TN01 - 1/5 HP - RESA ( 373W ) - POTENZAASSORBITA ( 250W )

ENTRO 10MT - UP TO 10MT - JUSQU A 10M- BIS 10M

14UC405TN01 - 1/4 HP - RESA ( 413W ) - POTENZAASSORBITA ( 281W )

L 2000

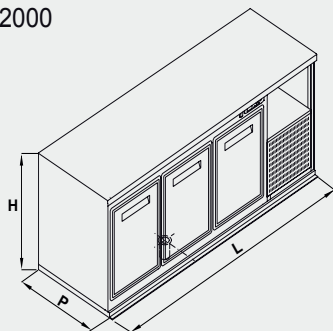

## BASE REFRIGERATA H 770

REFRIGERATED BASE H 770

BASE RÉFRIGÉRÉE H 770

GEKUEHLTES BASIS H 770

L	P	
L 2000 (3 FORI) STATICA	550	MI
	650	ME
		MI
		ME

MI - Motore interno-Internal motor-Moteur interne-Interner Motor

ME - Motore esterno non fornito - External motor not supplied - Moteur externe non fourni - Externer Motor, nicht mitgeliefert

ENTRO 3MT - UP TO 3MT - JUSQU A 3M- BIS 3M

14UC405TN01 - 1/4 HP - RESA ( 413W ) - POTENZAASSORBITA ( 281W )

ENTRO 10MT - UP TO 10MT - JUSQU A 10M- BIS 10M

14UC610TN02 - 1/3 HP - RESA ( 605W ) - POTENZAASSORBITA ( 415W )

L 2500

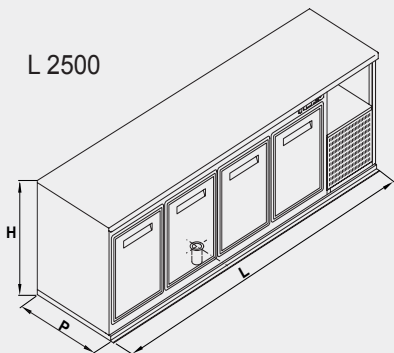

## BASE REFRIGERATA H 770

REFRIGERATED BASE H 770

BASE RÉFRIGÉRÉE H 770

GEKUEHLTES BASIS H 770

L	P	
L 2500 (4 FORI) STATICA	550	MI
	650	ME
		MI
		ME

MI - Motore interno-Internal motor-Moteur interne-Interner Motor

ME - Motore esterno non fornito - External motor not supplied - Moteur externe non fourni - Externer Motor, nicht mitgeliefert

ENTRO 3MT - UP TO 3MT - JUSQU A 3M- BIS 3M

14UC610TN02 - 1/3 HP - RESA ( 605W ) - POTENZAASSORBITA ( 415W )

ENTRO 10MT - UP TO 10MT - JUSQU A 10M- BIS 10M

14UC746TN01 - 3/8 HP - RESA ( 717W ) - POTENZAASSORBITA ( 486W )

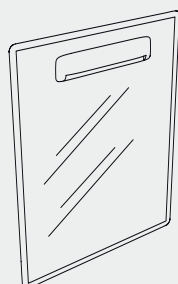

	H
TN DX	770
TN SX	770

## MAGGIORAZIONE SPORTELLO VETROCAMERA TN

ADDITIONAL CHARGE FOR CHAMBER GLASS DOOR TN

SUPPLÉMENT PORTILLON EN VERRE TN

AUFPREIS F. DOPPELGLASTÜR TN

## COMPONENTI SCAFFALI

Shelves component  
Meuble composants  
Regal Komponenten

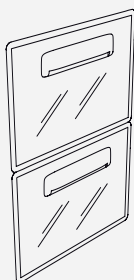

	P	H
	550	770
	650	770

### MAGGIORAZIONE CASSETTIERA DOPPIA IN VETROCAMERA

ADDITIONAL CHARGE FOR TWO-DRAWER UNIT IN CHAMBER GLASS  
SUPPLÉMENT MODULE À DOUBLE TIROIR EN VERRE  
AUFPREIS DOPPELSCHUBKASTEN DOPPELGLAS

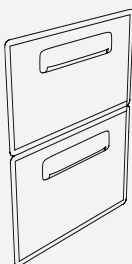

	P	H
	550	770
	650	770

### MAGGIORAZIONE CASSETTIERA DOPPIA UGUALE

ADDITIONAL CHARGE FOR TWO - DRAWER UNIT (SAME SIZED DRAWERS)  
SUPPLÉMENT MODULE À DOUBLE TIROIR IDENTIQUE  
AUFPREIS DOPPELSCHUBKASTEN GLEICH

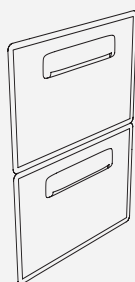

	P	H
	550	770
	650	770

### MAGGIORAZIONE CASSETTIERA DOPPIA DISUGUALE

ADDITIONAL CHARGE FOR TWO - DRAWER UNIT (DIFF.-SIZED DRAWERS)  
SUPPLÉMENT MODULE À DOUBLE TIROIR DÉPAREILLÉ  
AUFPREIS DOPPELSCHUBKASTEN UNGLEICH

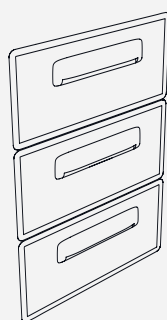

	P	H
	550	770
	650	770

### MAGGIORAZIONE CASSETTIERA TRIPLA

ADDITIONAL CHARGE FOR THREE - DRAWER UNIT  
SUPPLÉMENT MODULE À TIROIRS IDENTIQUE  
AUFPREIS DOPPELSCHUBKASTEN GLEICH

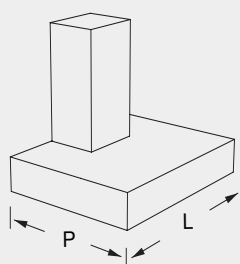

L	P	H
900	400	
1200	400	

### CAPPA ASPIRANTE MACCHINA CAFFÈ

ASPIRING HOOD FOR COFFE MACHINE  
CAPE ASPIRANTE POUR CAFETIERE  
SAUG-DUNSTABZUG FUER KAFFEMASCHINE

# COMPONENTI SCAFFALI

Shelves component  
Meuble composants  
Regal Komponenten

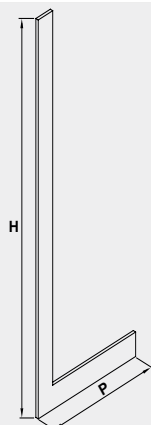

S	P	H
20	400	2400
20	550	2400
20	650	2400

## FIANCO TERMINALE PER SCAFFALE CON BASE MONTANTE

FINAL SIDE FOR SHELF WITH STAND BASE  
COTÉ TERMINALE POUR ÉTAGÈRE AVEC MONTANT DE BASE  
ENDESEITE FUER REGAL MIT STÄDERBASISELEMENT

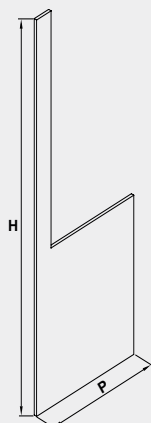

S	P	H
20	400	2400
20	550	2400
20	650	2400

## FIANCO TERMINALE IN LEGNO PER BASE ALTA P.40/55/65

FINAL SIDE IN WOOD FOR HIGH BASE P.40/55/65 (P=DEPTH)  
COTÉ TERMINALE EN BOIS POUR BASE DE HAUT P.40/55/65 (PROFONDEUR)  
ENDSEITE AUS HOLZ FUER SOCKEL HOCH P.40/55/65 (P=TIEFE)

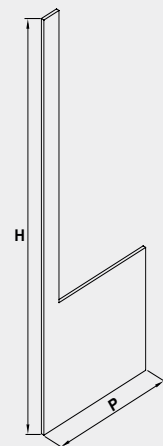

S	P	H
20	400	2400
20	550	2400
20	650	2400

## FIANCO TERMINALE IN LEGNO PER BASE BASSA P.40/55/65

FINAL SIDE IN WOOD FOR LOW BASE P.40/55/65 (P=DEPTH)  
COTÉ TERMINALE EN BOIS POUR BASE BASSE P.40/55/65 (PROFONDEUR)  
ENDSEITE AUS HOLZ FUER NICHTKÜHLBASISELEMENT P.40/55/65 (P=TIEFE)

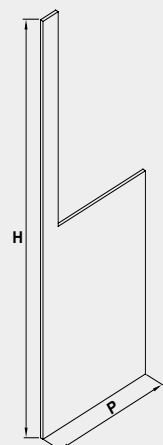

S	P	H
20	550	2400
20	650	2400

## FIANCO TERMINALE PER SCAFFALE CON BASE MACCHINA CAFFE P.55/65

FINAL SIDE IN WOOD FOR COFFE MACHINE BASE P.55/65 (P=DEPTH)  
COTÉ TERMINALE EN BOIS POUR CAFE' DE LA MACHINE BASE P.55/65 (PROFONDEUR)  
ENDSEITE AUS HOLZ FUER BASISMASCHINE KAFFEE P.55/65 (P=TIEFE)

# COMPONENTI SCAFFALI

Shelves component  
Meuble composants  
Regal Komponenten

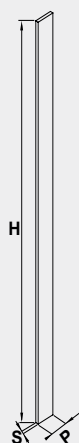

S	P	H
18	110	2400

## FIANCO TERMINALE PER MODULO MURALE

END SIDE PANEL FOR WALL MODULE  
TERMINAISON LATÉRALE POUR MODULE MURAL  
SEITENWAND FÜR WANDMODUL

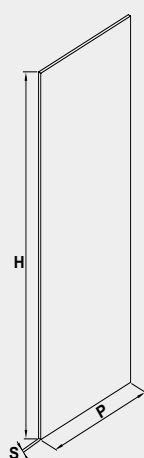

S	P	H
18	490	2400
18	640	2400
18	740	2400

## FIANCO TERMINALE ALTO PIENO PER SCAFFALE

END SIDE PANNEL FULL FOR SHELF  
TERMINAISON LATÉRALE COMPLET POUR ÉTAGÈRE  
SEITENWAND FÜR REGAL

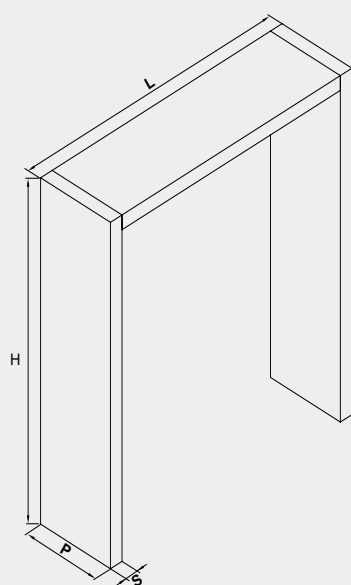

## PORTALE SCAFFALE GENIUS COMPOSTO DA:

GENIUS SHELVES PORTAL CONSISTING OF:  
PORTAIL DE ÉTAGÈRE GENIUS CONSISTANT EN :  
REGALSYSTEM GENIUS-PORTAL BESTEHEND AUS:

## COPPIA FIANCHI

PAIR OF SIDE PANELS  
JOUE DÉCORATIVE  
SEITENPAAR

S	P	H
100	490	2486
100	640	2486
100	740	2486

## CIELINO SUPERIORE AL ML. max.3 ml (ILLUMINAZIONE A LED - OPTIONAL)

UPPER CEILING PANEL BY ML. max.3 ml (INCREASE FOR LED/ML - OPTIONAL)  
CIEL AU MÈTRE COURANT max.3 ml (AUGMENTACION POUR LED ML- OPTIONAL)  
ABDECKUNG PRO METER max.3 ml (PREISAUFSCHLAG LED BELEUCHTUNG/ML - OPTIONAL)

100	490
100	640
100	740

## COMPONENTI SCAFFALI

Shelves component  
Meuble composants  
Regal Komponenten

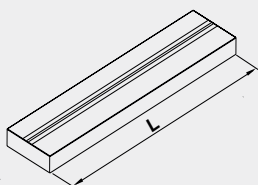

L

750

1000

### PLAFONIERA LED INCASSO LINEARE

LINEAR RECESSED LED CEILING LIGHT  
LUMIÈRE DE PLAFOND LED À ENCASTRÉ LINÉAIRE  
LINEAR EINBAU LED-DECKENLEUCHTE

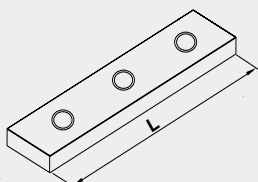

L

750

1000

### PLAFONIERA ILLUMINATA CON FARETTI

ILLUMINATED CEILING LAMP WITH SPOTLIGHTS  
LAMPE DE PLAFOND LUMINEUSE AVEC DES PROJECTEURS  
BELEUCHTETE DECKENLEUCHTE MIT SPOTLIGHTS

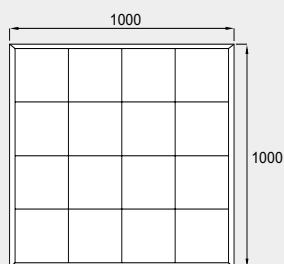

### PIASTRELLE A QUADRO 24X24 / AL MQ

SQUARE TILES 24X24 / AL MQ  
CARREAUX CARRES 24X24 / AL MQ  
QUADRATISCHE FLIESEN / AL MQ

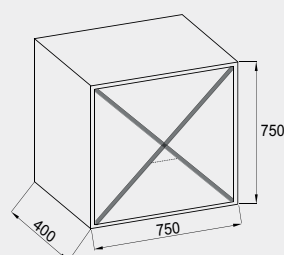

### BOX VINI L750 X H750 X P400

WINE BOXES L750 X H750 X P400  
BOITES A' VIN L750 X H750 X P400  
WEINKISTEN L750 X H750 X P400

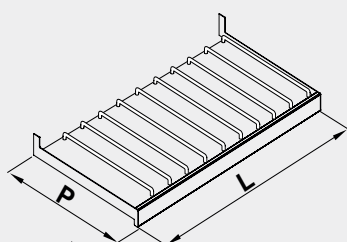

L

P

750

350

1000

350

750

400

1000

400

### MENSOLA VINI CON REGGIMENSOLA

WINE SHELF WINE SHELF WITH SHELF HOLDER  
TABLETTE À VIN AVEC PORTE- TABLETTE  
WEINREGAL MIT BRETT-HALTER